



Crystalline silicon PV module installation guide

1.Introduction

1.1 Purpose

This document provides detailed instructions and valuable safety information regarding the installation, electrical connection and maintenance of the following JINERGY Crystalline Photovoltaic modules, involved module series are as follow Table 1:

JNMM120-XXX
JNMM144-XXX

Table 1

All instructions and mechanical and electrical requirements should be read and understood before attempting installation.

The installer should conform to all safety precautions in this guide when installing the module. Keep this guide in a safe place for further reference.

1.2 Limitation of Liability

Because the use of this manual and the conditions or methods of installation, operation, use and maintenance of photovoltaic (PV) products are beyond JINERGY control, JINERGY does not accept responsibility and expressly disclaims liability for loss, damage, or expense arising out of or in any way connected with such installation, operation, use or maintenance. JINERGY reserves the right to change the manual without prior notice.

1.3 Others

1.3.1 Modules rated for use in this application class may be used in systems operating at greater than 50V DC or 240W, where general contact access is anticipated. Modules qualified for safety through IEC 61730-1 and this part of IEC 61730 within this application class are considered to meet the requirements for safety class II.

1.3.2 Where common grounding hardware (nuts, bolts, star washers, spilt-ring lock washers, flat washers and the like) is used to attach a listed grounding/bonding device, the attachment must be made in conformance with the grounding device manufacturer's instructions.

2.Safety

2.1 General Safety

- 2.1.1 Consult and follow local codes and other applicable laws concerning required permitting as well as installation & inspection requirements, rules, and regulations.
- 2.1.2 PV modules should be installed and maintained by qualified personnel.
- 2.1.3 Use the same performance modules within a given series.
- 2.1.4 Follow all safety precautions of all components used in the system.
- 2.1.5 Do not shade portions of the PV module surface from the sun for a long period of time. The shaded cell may become hot (hot spot phenomenon), which can result in solder joints peeling off.
- 2.1.6 Do not clean the glass surface with chemicals.
- 2.1.7 Do not drop the PV module or drop objects onto the PV module.
- 2.1.8 Do not concentrate sunlight on the modules or panels.
- 2.1.9 Do not attempt to disassemble the modules, and do not remove any attached components from the modules.
- 2.1.10 Do not scratch or hit at the back sheet, the glass, the terminal box. Do not pull the cables or touch them with bare hands.
- 2.1.11 Do not drill holes in the frame or scratch the insulating coating of the frame.
- 2.1.12 Keep the PV module packed in the carton until installation.
- 2.1.13 Do not use modules near equipment or in places where flammable gases may be generated.
- 2.1.14 External or otherwise artificially concentrated sunlight shall not be directed onto the front or back face of the PV module.
- 2.1.15 PV connector model is the model MC4 of compatible , other connectors which in addition must be suit to the model MC4 of compatible.

2.2 Installation Safety

- 2.2.1 Wear protective head gear, insulating gloves, safety shoes, and insulated tools when installing the modules.
- 2.2.2 Do not install the modules in rain, snow, or otherwise wet or windy conditions.
- 2.2.3 Completely cover the PV module surface with an opaque material during PV module installation and wiring to prevent accidental charge buildup.
- 2.2.4 Plug in connectors tightly when working on wiring.

- 2.2.5 Due to the risk of electrical shock, do not perform any work if the terminals of PV module are wet.
- 2.2.6 Do not touch the terminal box and the end of output cables (connectors) with bare hands.
- 2.2.7 Do not unplug the connector under load.
- 2.2.8 Do not work alone.
- 2.2.9 Wear a safety belt if working far above the ground.
- 2.2.10 Do not wear metallic jewelry, which can cause electric shock, while installing or troubleshooting the PV system.
- 2.2.11 Follow the safety regulations for any and all other system components, including wires, connectors, charging regulators, batteries, inverters, etc.
- 2.2.12 Do not expose wires to direct sunlight. Use UV-resistant cabling.
- 2.2.13 Do not damage the surrounding PV modules or mounting structure when replacing a PV module.
- 2.2.14 Do not change any PV module components (diode, junction box, plug connectors, etc.).
- 2.2.15 Maximum reverse current is 20.25A for module with 6 inch cells. Use a blocking diode and maximum series overcurrent protective device in the combiner box are recommended for reverse current protection when more than three strings are connected in parallel.
- 2.2.16 The solar modules are recommended to be installed over a fireproof and insulating roof covering when installed on a roof.
- 2.2.17 Module may not be contacted during working.
- 2.2.18 It is recommended to use jinergy type PV-JN02 , 5.7~7.1 mm cable for connector which supplied by module factory, these connectors are not recommended to replace the module connector
- 2.2.19 The minimum bended radius is 43mm and prohibit to excessively bend. After the assembly is installed, the cable shall be fixed in time, and the cable shall not swing back and forth for a long time (Suitable for positive and negative cable) .



Cable Bended radius











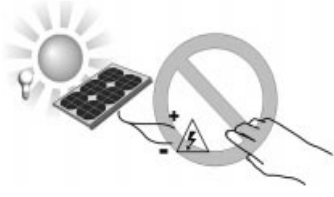

Fail







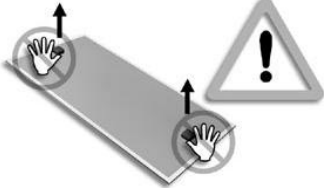

Pass

Fail

Pass

2.3 Installation matters needing attention

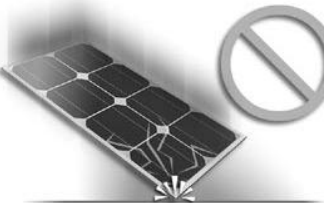
	<p>Solar module (hereinafter referred to as the "components") under the sun can produce more than 30 v voltage. The voltage exceeds the safety voltage range. So the electrical connection parts such as improper operation which sparks cause fire, electric shock, and even, so regardless of the component in any case, don't direct contact with the terminal.</p> 
	<p>Module for outdoor use, can be installed on the roof, vehicles, ships, etc. Installed in different attachments should be used for mounting bracket. Do not remove or moving components of any such as frame, glass, label, junction box adhesion on the module parts.</p> 
	<p>Don't attempt to daub on the surface of the module or paste any object.</p> 
	<p>Do not use a mirror, lens, or similar articles focus sunlight onto the module.</p> 
	<p>In the process of transportation and installation of module, please do not let the child contact and away from modules and solar photovoltaic power generation systems.</p> 
	<p>Do not place the module in the combustible gas easy generation or congregate.</p> 

	 <p>In the process of moving module, do not grab junction box and cable, should contact the module frame for handling.</p>
	 <p>In any case, please don't trample modules.</p>
	 <p>To protect the glass is damaged, please do not place heavy objects on the module or throwing have damage to any of the items out of modules.</p>
	 <p>Careful handling, avoid knock against. Improper handling and placement, may cause module of glass breakage and loss of performance, which affects the output</p>

3. Mechanical Installation

3.1 Installation Condition

3.1.1 Environment temperature: -40 to 85°C

3.1.2 Operating temperature: -40 to 85°C

3.1.3 The maximum altitude of the PV module is designed: 2000 m

3.1.4 Mechanical load on panels (e.g., from wind or snow): wind load less than 2400 Pa /snow load less than 5400 Pa

3.1.5 Tilt Angle selection: The installation should be facing north in the southern hemisphere and facing south in the northern hemisphere.

3.1.6 To maintain the modules' Class C fire rating, the fire class of the roof and building materials should higher than Class C. The fire rating of this module is valid only when mounted in the manner specified in the mechanical mounting instructions.

3.1.7 Raise the distance when installation requirement is greater than or equal to 0.3 m. Module installation use

appropriate installation angle, refer to the following Table 2.

Local latitude	Installation angle
0°~15°	15°
15°~25°	latitude
25°~30°	latitude+5°
30°~35°	latitude+10°
35°~40°	latitude+15°
> 40°	latitude+20°

Table 2

3.2 Installation Methods

3.2.1 Bolting

All modules must be securely fastened with at least 8 bolts (Fig. a). For maximum security against strong winds or heavy snow falls, suggestion for all of the mounting holes should be used. Modules must be laid across the supporting bars (The supporting bars width should be 40~80mm)

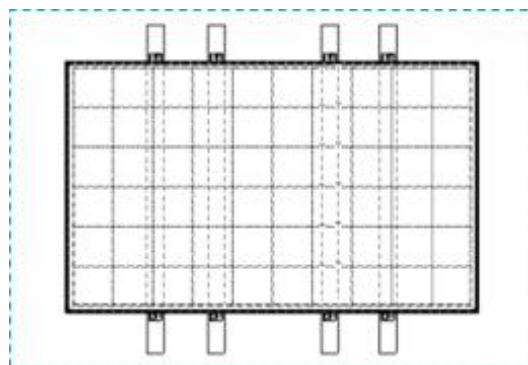

Fig. a

Bolts are inserted as described in the process below (Fig. b).

1. Place the module on the supporting bars underneath (The modules should directly touch with the supporting bar) .
2. Insert stainless-steel bolts (M6 or M8) through the holes (use M6 series mounting accessories when the size of mounting holes is 7x11.5mm and use M8 series when the size is 9x13mm) in the frame according to the Fig. a. For maximum security against strong winds and heavy snow, all available mounting holes should be used.
3. Secure each bolt to the frame with 2 stainless-steel washers, one on each side of the mounting structure; and screw on either a stainless-steel spring washer or a toothed lock washer. Finally, secure with a stainless

steel nut (M6 or M8).

4. The torque for tightening the nut and bolts recommended 13Nm when the property class of bolts and nuts is Class 8.8

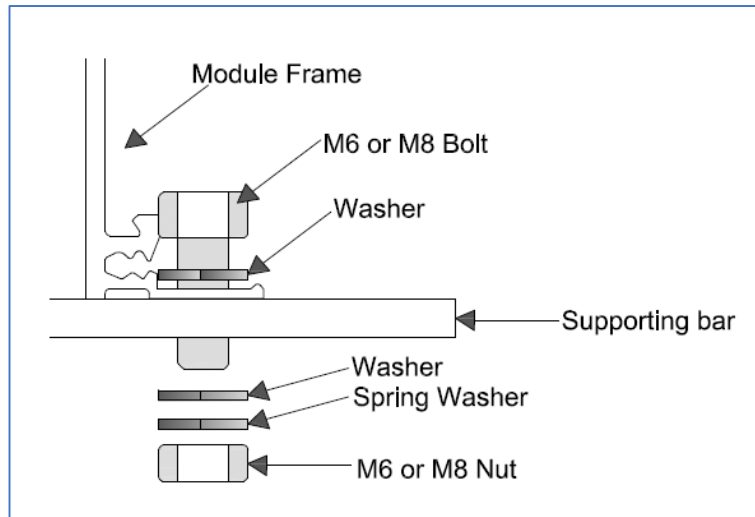

Fig. b

3.2.2 Clamping

Modules must be laid either across the supporting bars (The supporting bars width should be 40~80mm) (Fig. c) or parallel to them (Fig. d & e).

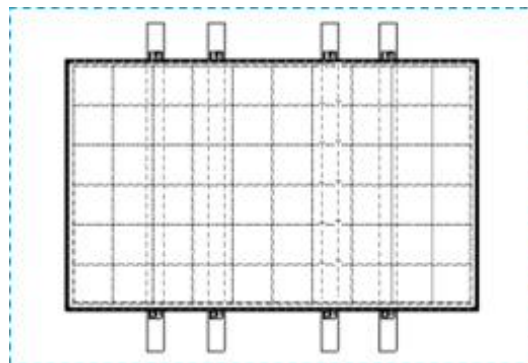

Fig. c

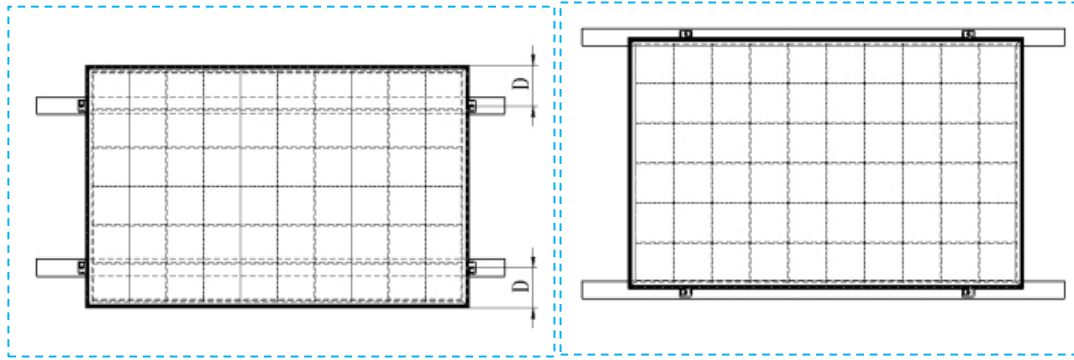

Fig. d

Fig. e

Remark: Illustrations of the three different methods for clamping modules onto the frame with aluminum clamps.

Each aluminum mounting clamp comes with an M8 bolt, a plain washer, a spring washer, and an M8 nut. To fasten the module:

1. Place the module on the two supporting bars (not provided). The bars should be made with stainless material or treated with an anti-corrosion process (e.g., anodic oxidation treatment).
2. The bar's top surface contacted with module frame should come with grooves compatible with an M8 bolt.
3. If the bars do not come with grooves, holes of a suitable diameter may need to be drilled to allow bolts to be attached to the bars at the same locations as mentioned before.
4. Secure each clamp by attaching plain washer, spring washer, and nut, in that order.
5. Both of close-ups of Fig. f indicate the middle clamps and Fig. g indicate the side clamps for your reference. The dimensions for the middle clamps are $a \geq 40$ mm, $b \geq 26$ mm, $c = 8$ mm, $d \geq 28$ mm, and $\varnothing = 9$ mm. The torque for tightening the nut and bolts recommended 28Nm when the property class of bolts and nuts is Class 8.8.

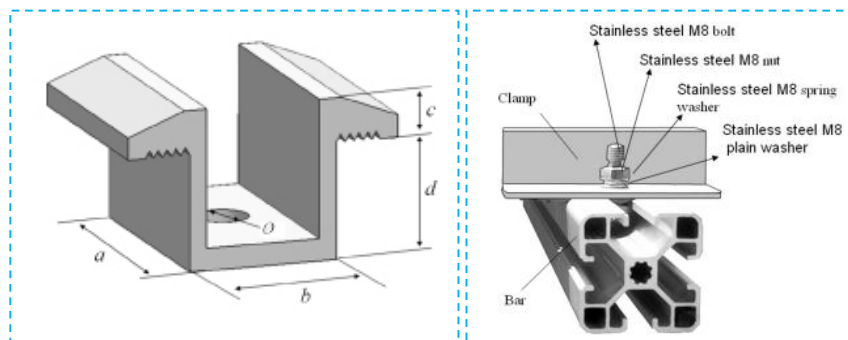
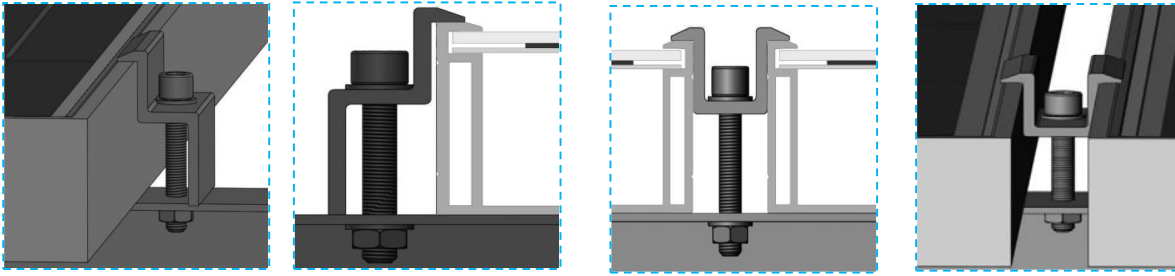

Fig. f

Fig. g



End Clamp installation

Middle Clamp installation

6. Especially for Fig. c mounting method, slide bolts through groove on the supporting bars next to the locations where the clamps are to be fastened. The module may be clamped only in the permitted clamping area as on the long edge of the frame, and the edge of the clamp should not coincide with the position of the mounting hole. For exact locations on the frame refer to Fig. h in conjunction with Table 3 below.

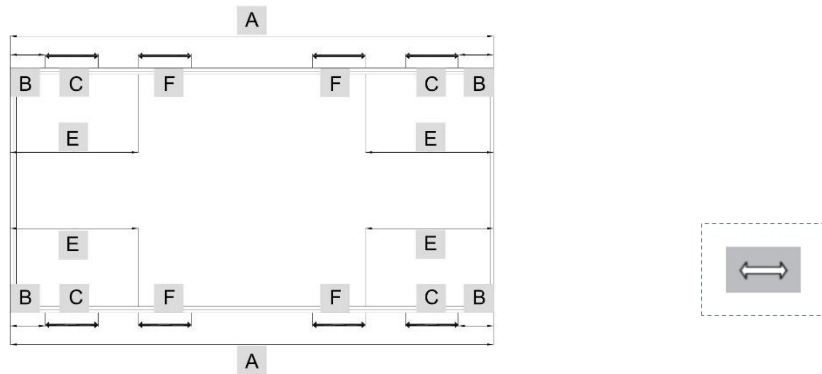

Fig. h

Variable clamping range

For exact dimensions for a given module series, please see the following Table 3. Use in conjunction with Fig. i to determine permitted clamping locations for a given module series for clamping with clamps.

Module	Series Dimension (mm)	A (mm)	B (mm)	C (mm)	E (mm)	F (mm)
JNMM120-XXX	1761/1765/1776*1038/1048/1052*35/40/45	1761/1765/1776	180	100	335	100
JNMM120-XXX	1755*1038*35	1755	175	100	330	100
JNMM144-XXX	2101/2108/2115*1038/1048/1052*35/40/45	2101/2108/2115	355	100	505	100
JNMM144-XXX	2094*1038*35	2094	345	100	500	100

Table 3

7. Especially for Fig. (d) mounting method which is only suitable for JNMM120 series modules, clamp positions are important – the clamp centerlines refer to mark “D” which must be between 50mm and 200mm from the end of the module.

8. Especially for Fig. e mounting method, the modules may be mounted using clamps designed for solar modules refer to Fig. i, the modules must be supported along the length of the long edge and should overlap

the array rail by 10mm – 14mm. The module may be clamped only in the permitted clamping area as on the long edge of the frame. For exact locations on the frame refer to Fig. h in conjunction with Table 3.

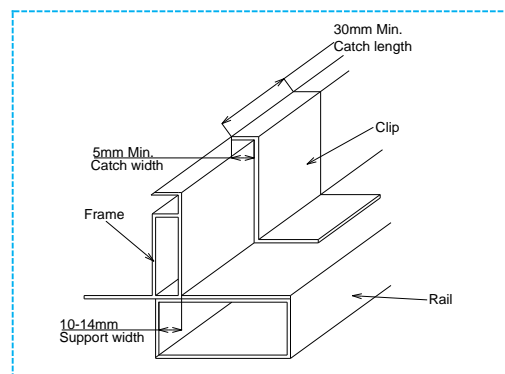

Fig. i

3.3 Stent

1. Please obey the instructions and safety regulations on racks. From bracket suppliers if necessary, can obtain more information on support;
2. Module frame provided on the back of at least 8 fixed hole used for fixed installation, please don't in the module of drilling hole on aluminum alloy frame, such as drilling, is likely to affect the service life of module;
3. Module must be installed in the frame of the plane. Entire squadron composed of modules and support system must be able to withstand the wind and snow load must produce mechanical stress;
4. A stent of heat bilges cold shrink stress should not impact on the performance of the module and use;
5. Stent must by weather resistance, corrosion resistance, uv resistance materials, general use of steel or aluminum alloy materials.

Note: if the module of drilling hole on aluminum alloy frame, will not be guaranteed the product quality assurance period

3.4 Ground and roof installation

3.4.1 Ground installation

Choose to install the height of the need to guarantee the minimum edge module is covered with snow, vegetation cover, not by local sand damage caused by wind, suggest installation height not less than 300 mm.

3.4.2 Roof installation

1. On the roof and building installation process, to ensure the module installation is firm, avoid module

- drop caused by the not installed firmly make its damage, or causing casualties;
2. Convenient for daily maintenance and reduce the water vapor condensation caused harm, the back of the module needs to have enough space. So in custom installation scheme and the installation process, to ensure that the back of the module and installation plane, have enough distance between recommended minimum distance is 50 mm;
 3. Module roof installation, could affect the roof structure safety, it is necessary to use grounding failure protector, wrong installation can cause accident harm;
 4. Solar modules installed on the roof, suggest the upper module is installed on fire protection and insulation.
 5. In strong winds weather condition, please do not install the modules.

4. Electrical Installation

Details for electrical installation in accordance with the IEC61730-1

4.1 Installation

- 4.1.1 The maximum system voltage for all module series is 1000 V/1500V
- 4.1.2 Connect quantity of modules that match the voltage specifications of the inverters used in system. Modules must not be connected together to create a voltage higher than the permitted maximum system voltage under the worst local temperature conditions.
- 4.1.3 Under normal conditions, a photovoltaic module is likely to experience conditions that produce more current and/or voltage than reported at standard test conditions. The requirements of the National Electrical Code (NEC) in Article 690 shall be followed to address these increased outputs. In installations not under the requirements of the NEC, the values of ISC and VOC marked on this module should be multiplied by a factor of 1.25 when determining component voltage ratings, conductor capacities, over current device ratings, and size of controls connected to the PV output.
- 4.1.4 Each module (or series-connected string of modules) shall be provided with the maximum series overcurrent protective device, specified as 20A for the 6 inch cell module series.
- 4.1.5 Use a special solar cable and plugs for installing the PV system and make sure that all connections are safe and tight. The cable cross section size should be 4mm² (12AWG) and able to withstand the maximum possible system open-circuit voltage.

4.1.6 Bypass diodes are included in module junction boxes to avoid decreased module performance in the event of shade or shelter. Please check the relevant product datasheet for the specific diodes of J-box.

4.1.7 Maximum series / parallel PV module configurations can be referred to the Table 4.

Module Type	Cmax (1000V)	Cmax (1500V)
JNMM120	22	32
JNMM144	18	28

Table 4

4.2 Grounding

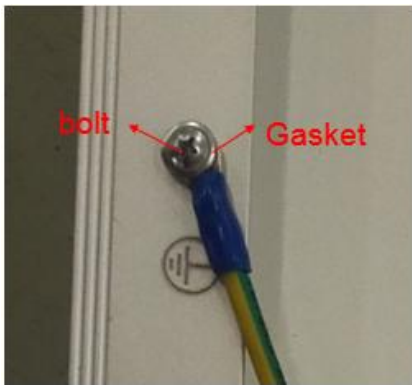

Fig. j



Toothed washer



nut

Grounding the aluminum frame with copper wire

4.2.1 Use the marked 5.5 mm grounding holes (5.5mm) to ground the anodized frame. All nuts, bolts, and gasket are type M5 and should be made of stainless steel (Fig. j).

4.2.2 Put the bolt through the Fixed end and then through the hole in the aluminum frame.

4.2.3 Add the gasket and nut on the other side of the bolt and tighten to secure all parts. The tightening torque should be $2.1 \pm 0.1 \text{ Nm}$. (Note that the copper wire cannot be attached directly to the aluminum.)

To suggest grounding method above, also can use in line with the national electrical grounding method of relevant norms.

5.Maintenance and Disposal





5.1 Regularly carry out a visual inspection for dirt, dust, bird dropping, leaves, and other detritus covering the modules.

- 5.2 If there is a build-up of dirt or dust on the module surface, wash the module with clean water and a gentle implement (a sponge). Never use chemicals on the surface of the module.
- 5.3 If snow is present, a soft-bristled brush with soft bristles may be used to clean the surface of the modules.
- 5.4 Regular electrical and mechanical inspection by a licensed professional will keep the system safe and operating at maximum efficiency.

6.Others







6.1 Module Unloading

Unloading for container



S/N	Operating procedure	Photo	Control Point
1	<ul style="list-style-type: none"> • If the container is on the ground, the module can be unloading directly. 		<ul style="list-style-type: none"> • If the container is not full, the people need to cut the bandage when unloading (If the container is full, the bandage is none). 
2	<ul style="list-style-type: none"> • If the container is on the flatbed trailer, the module need a landing platform when unloading. 		<ul style="list-style-type: none"> • Before the forklift operate, add some buffer articles at the forklift arm to avoid damaging the module. • Box transportation needs to keep horizontal or tilted to the direction of forklift. • The vertical surface of the forklift arm should be smooth and there are no something that sticks out. • Start from the short side of the packing box, reduce modules that are broken. • When second transportation, a special person should be command to carry, and it is prohibited to damage the packing box.
3	<ul style="list-style-type: none"> • The forklift can loading 2T or more, raising the module smoothly pull out and keep slow speed when holding the module. 		<ul style="list-style-type: none"> • If the forklift hold up from the short side, forklift arm length of about 1520 mm or more. • Box transportation needs to keep horizontal or tilted to the direction of forklift. • The surface of the forklift arm should be smooth.

6.2Module Storage

Operating procedure of unpacking

S/N	Operating procedure	Photo	Control Point
1	<ul style="list-style-type: none"> Cut off the packing tape, remove the top package down and hold on flat floor. 		
2	<ul style="list-style-type: none"> Cut off the packing tape and remove the box cover. 		<ul style="list-style-type: none"> Operators must wear gloves to prevent scratching of their hands by frame and keep the glass surfaces clear.
3	<ul style="list-style-type: none"> Cut off the inner packing belt. Don't scratch the aluminum frame when cutting the packing belt. 		
4	<ul style="list-style-type: none"> Two professional people unpacking the module together from back side. When take off the last eight modules, the outermost module must be slanted to lean on the other modules (If not may result in hidden cracks or damage when the module tilted). 		

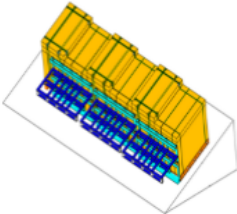
Storage for modules

S/N	Operating Procedure	Photo	Control Point
1	<ul style="list-style-type: none"> The module would be best set on the flat floor, stand side by side and place neatly. 		<ul style="list-style-type: none"> To same color and current modules, try to make sure that they are placed together for easy management.
2	<ul style="list-style-type: none"> If the ground is not flat or the slope is small, the stacked package must be break down, the short part of carton is facing down, stand side by side and place neatly. Module are not allowed to place on steep ground. When second transportation, a special person should be command to carry, and it is prohibited to damage the packing box. 		<ul style="list-style-type: none"> The pallet should be pulled firmly as following. 
3	<ul style="list-style-type: none"> The module should be protect when raining or wet, which wrapped by waterproof. 		<ul style="list-style-type: none"> It should be protected by waterproof whether above two methods.

Storage for scattered modules

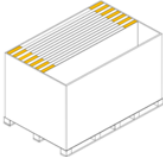
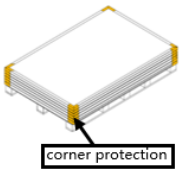
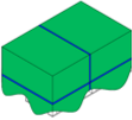
S/N	Operating procedure	Photo	Control Point
1	<ul style="list-style-type: none"> If unpacked modules do not installed completely. 		<ul style="list-style-type: none"> It can not remain in the box for long time, if it is necessary to storage the unpacked modules, we suggest the following method.
2	<ul style="list-style-type: none"> Place the modules on the pallet. 		<ul style="list-style-type: none"> The pallet need to put on the flat ground. The glass of first module need to face upward, it need to face down from second module. It can not more than 10 Pcs/pallet totally. It is forbidden that carry module by cable of junction box. The modules should be stacked neatly, avoid the glass blasting because of dislocation. Do not allowed to carry modules in the this case. It is not allowed two or more adjacent modules which have no corner protection.
3	<ul style="list-style-type: none"> Modules should be wrapped by waterproof. 		

6.3 Installation method

Installation method

State :

- The modules which installed at one series should be same power, same color, same current
 Power : ③ of [dexter](#) picture
 Color : ⑤ of [dexter](#) picture
 Current : ⑧ of [dexter](#) picture
- If the modules must be gathered together, we suggest that the first mix colors, secondly mix current, mixed power is not recommended.
- Only high current modules can mixed into low current modules series.
- The strapping tape of cable need to use scissors to cut open, can't catch the connector pull off.
- If there is tape to hold the cables on the [backsheet](#), remove it before installation.
- During installation, the [backsheet](#) of the modules shall not be scratched.
- Do not tread module in any case.
- Where there are sandstorm, the module connector should immediately connect after a short period , or do sand protection, avoid sand enter into the connector and affect the installation.

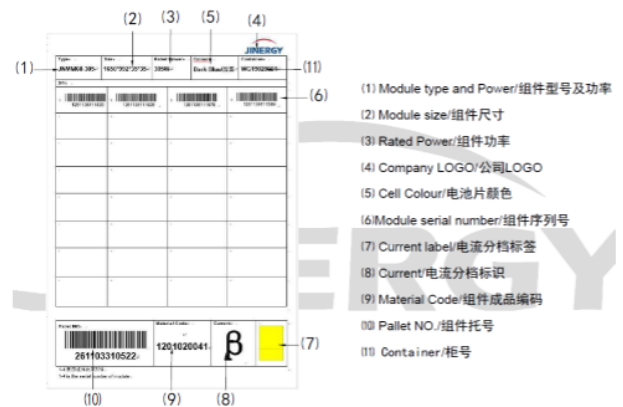

Note : All the above are sketch map